





# APPROVAL SHEET

CUSTOMER : \_\_\_\_\_  
 DEVICE NAME : IR RECEIVER MODULE  
 CODE No. : \_\_\_\_\_  
 ITEM No. : ROM-VB138THC2  
 ISSUED DATE : 2012. 07. 25

**[ CUSTOMER APPROVAL ]**



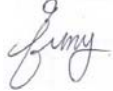

ACCEPT No.				
ACCEPT DATE				
ACCEPT	INSPECTER	CHECK	APPROVAL	COMMENT

	ISSUE	REVIEW	REVIEW	APPR'D
ISSUED DEPT.				



Tel : 82-42-863-2840  
 Fax : 82-42-861-0843  
<http://www.raytron.co.kr>

CUSTOMER :

<b>RECORD OF REVISION</b>				DATE		2012. 07. 25			
				MODEL NAME					
PART NAME		IR RECEIVER MODULE		TYPE No.		ROM-VB138THC2			
PART No.				APPROVAL DATE		2012. . .			
No.	DATE	PAGE	REVISED CLAUSE	REVISION DETAILS			Ma	Ch	AP
1	'12.07/25		Initial				Park	Jang	Jung
 <b>RAYTRON CO., LTD.</b> <b>HEAD OFFICE &amp; FACTORY (KOREA)</b> 104-6, Moonji-Dong, Yusung-Gu, Daejeon, KOREA TEL : +82-42-863-2840 FAX : +82-42-861-0843 <b>FACTORY (CHINA)</b> 6/F, BlockA, Huafeng GongYeYuan, Bao'an72, Shenzhen, CHINA TEL : +86-755-2744-7373 FAX : +86-755-2744-7235				MANAGER	CHECK	APPROVAL			
									
				FILE No.	RIS-120725-01				

CUSTOMER :

<b>SPECIFICATIONS</b>		SHEET No.	1 of 8
		DATE	2012. 07. 25
PART NAME	IR RECEIVER MODULE	MODEL NAME	
PART No.		TYPE No.	ROM-VB138THC2

**1. Description**

The ROM-VB1xx Series are miniaturized receiver for infrared remote control system. The Pin Photodiode and preamplifier are assembled on lead frame. The epoxy package is designed as IR filter.

The module has excellent performance even in disturbed ambient light application and provides protection against uncontrolled output pulses.

Korea Factory : Front part Raytron Co.,Ltd.(Korea) 104-6, Moonji-Dong, Yusung-Gu, Daejeon, KOREA  
 China Factory : End part Raytron Co.,Ltd.(China) 6/F, BlockA, Huafeng GongYeYuan, Bao'an72, Shenzhen,CHINA

**2. Features**

- 1) Transfer mold package.
- 2) Wide operating supply voltage 2.7V ~ 5.5V
- 3) Supply current : 3.3V(0.37mA), 5.0V(0.43mA)
- 4) Band pass filter center frequency : 37.9Khz
- 5) Epoxy IR filter characteristic : 940nm
- 6) Maximum interference safety against optical and electrical disturbance.
- 7) Internal filter for a high frequency lighting fluorescent lamp.
- 8) Internal Pull-Up output.
- 9) Lead(Pb)-free component.

**3. Application**

- 1) AV instruments (DVD, TV, SVR, Audio, CD player)
- 2) Home appliances (Air conditioner, Computer, Camera)
- 3) Remote control for wireless equipment.
- 4) Infrared remote control Toys.

**4. Block Diagram**

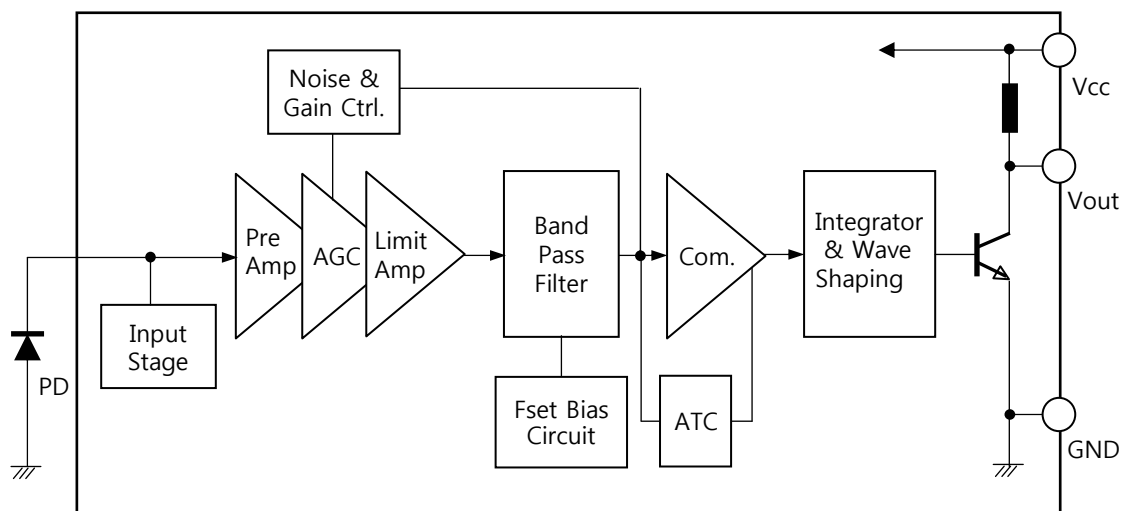

 <p><b>RAYTRON CO., LTD.</b>                  HEAD OFFICE &amp; FACTORY (KOREA)                  104-6, Moonji-Dong, Yusung-Gu, Daejeon, KOREA                  TEL : +82-42-863-2840 FAX : +82-42-861-0843                  FACTORY (CHINA)                  6/F, BlockA, Huafeng GongYeYuan, Bao'an72, Shenzhen, CHINA                  TEL : +86-755-2744-7373 FAX : +86-755-2744-7235</p>	MANAGER	CHECK	APPROVAL
			
	FILE No.	RIS-120725-01	

CUSTOMER :

<b>SPECIFICATIONS</b>		SHEET No.	2 of 8
		DATE	2012. 07. 25
PART NAME	IR RECEIVER MODULE	MODEL NAME	
PART No.		TYPE No.	ROM-VB138THC2

### 5. Electro-Optical Characteristics

1) Absolute Maximum Ratings (at 25°C Unless otherwise note)

Parameter	Symbol	Ratings	Unit
Supply Voltage	Vcc	6.0	V
Output Current	Iout	2.0	mA
Operating Temperature	Topr	-20 ~ +85	°C
Storage Temperature	Tstg	-40 ~ +90	°C
Soldering Temperature (*1)	Tsol	260, t<10sec	°C

(\*1) For 10sec (at mounting on PCB with thickness of 1.6mm)

2) Recommended Operating Conditions

Parameter	Symbol	Ratings	Unit
Operating Voltage	Vcc	2.7 ~ 5.5	V
Input Frequency	fin	30 ~ 60	kHz

3) Electro-Optical Characteristics (Ta=25°C)

Parameter	Symbol	Conditions	Min	Typ	Max	Unit
Supply Voltage	Vcc		2.7	-	5.5	V
Supply Current	Icc	N/signal (3.0V)	0.25	0.37	0.42	mA
		N/signal (5.0V)	0.38	0.43	0.45	mA
Peak Wavelength (※1)	$\lambda_p$		-	940	-	nm
B.P.F Center Frequency (※2)	fo		-	37.9	-	kHz
High Level Output Voltage (※1)	VOH		Vcc-0.5	-	-	V
Low Level Output Voltage (※1)	VOL		-	0.2	0.4	V
High Level Output Pulse Width (※1)	tWH	Burst Wave = 600 $\mu$ s	400	-	800	$\mu$ s
Low Level Output Pulse Width (※1)	tWL	Period = 1.2ms	400	-	800	$\mu$ s
Internal Pull-up Resistance	Rout			40		k $\Omega$
Arrival Distance (※1)	D	$\pm 0^\circ$	-	13	-	m
		$\pm 30^\circ$	-	11	-	m
Output Form	Active Low Output					

※1. Distance between emitter and detector specifies maximum distance that output wave form satisfies the standard (fig.2, fig3) under the conditions below against the standard transmitter.  
ON/OFF pulse width is to be satisfied within 0.3m~ arrival distance length.

※2. The following band pass frequencies are available (32.7kHz/36.7kHz/37.9kHz/40kHz/56.7kHz)  
carrier frequencies are adjusted by zener-diode fusing method.

 <b>RAYTRON CO., LTD.</b> <b>HEAD OFFICE &amp; FACTORY (KOREA)</b> 104-6, Moonji-Dong, Yusung-Gu, Daejeon, KOREA TEL : +82-42-863-2840 FAX : +82-42-861-0843 <b>FACTORY (CHINA)</b> 6/F, BlockA, Huafeng GongYeYuan, Bao'an72, Shenzhen, CHINA TEL : +86-755-2744-7373 FAX : +86-755-2744-7235	MANAGER	CHECK	APPROVAL
			
	FILE No.	RIS-120725-01	

<h1>SPECIFICATIONS</h1>		SHEET No.	3 of 8
		DATE	2012. 07. 25
PART NAME	IR RECEIVER MODULE	MODEL NAME	
PART No.		TYPE No.	ROM-VB138THC2

4) Measurement Conditions

① Fig.1 Burst wave, Output wave

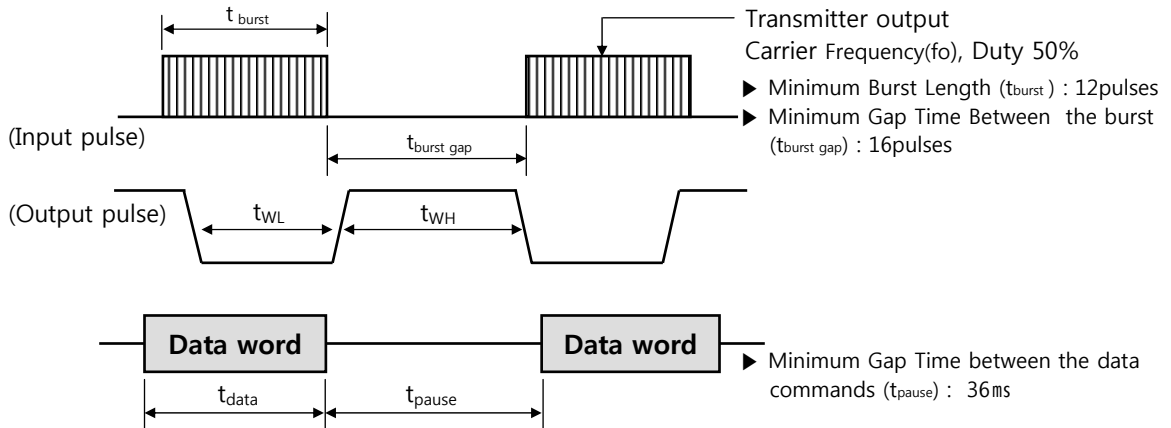

② Fig.2 Application Circuit

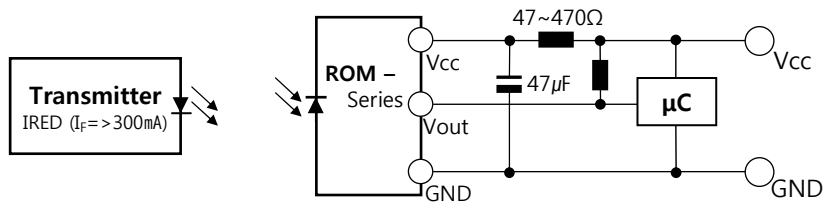

Please add the RC filter, resistor(40~470Ω) to Vcc line and , Condenser(47μF~470μF) between Vcc and GND, in order to reduce the noise from power supply line.  
In addition, infrared LED used in the transmitter is set to  $\lambda_{peak}=940nm$  and current ( $I_F = >300mA$ )

③ Fig.3 Test Condition of Arrival Distance

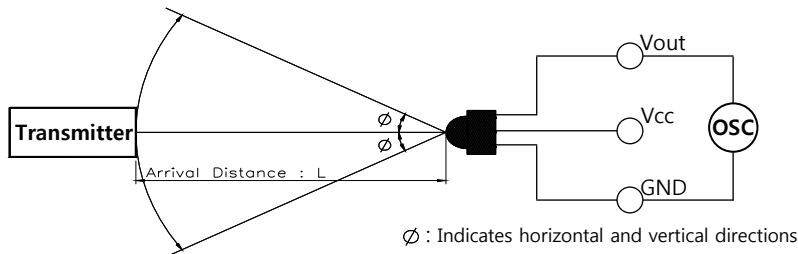

Ambient light source : Detecting surface's illumination shall be 100Lux under ordinary white fluorescence lamp without high frequency lighting.



**RAYTRON CO., LTD.**

HEAD OFFICE & FACTORY (KOREA)  
104-6, Moonji-Dong, Yusung-Gu, Daejeon, KOREA  
TEL : +82-42-863-2840 FAX : +82-42-861-0843

FACTORY (CHINA)  
6/F, BlockA, Huafeng GongYeYuan, Bao'an72, Shenzhen, CHINA  
TEL : +86-755-2744-7373 FAX : +86-755-2744-7235

MANAGER	CHECK	APPROVAL
FILE No.	RIS-120725-01	

CUSTOMER :

<h1>SPECIFICATIONS</h1>		SHEET No.	4 of 8
		DATE	2012. 07. 25
PART NAME	IR RECEIVER MODULE	MODEL NAME	
PART No.		TYPE No.	ROM-VB138THC2

5) Graph of Electrical/Optical Characteristics

[ Fig.1 ] Supply Current vs. Voltage

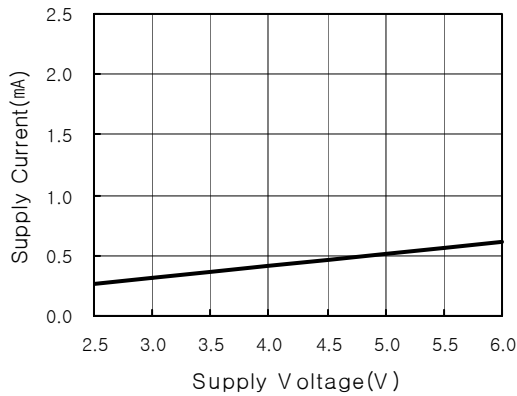

[ Fig.2 ] Sensitivity vs. Supply Voltage

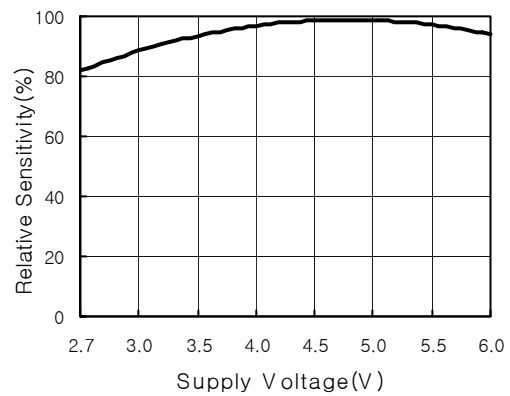

[ Fig.3 ] Output Pulse Width vs. Distance

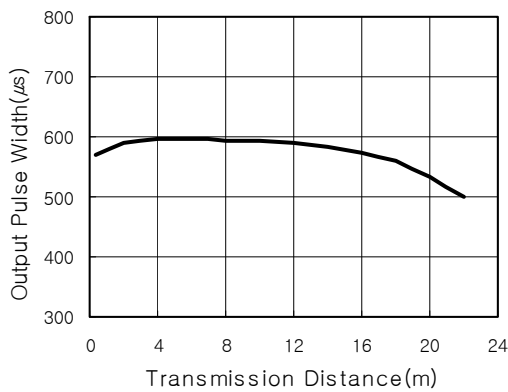

[ Fig.4 ] Relative Sensitivity vs. Direction

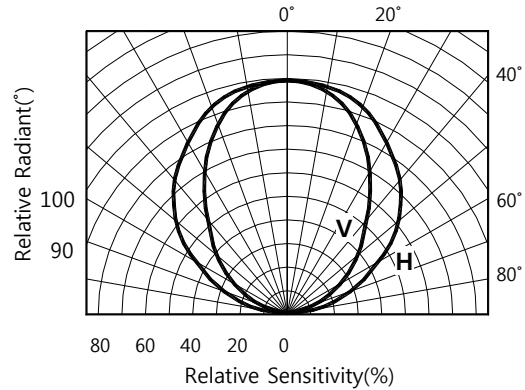

6) Standard Inspection

All output products shall be inspected based on following items.  
And Quality is guaranteed by last Out-Going Sampling inspection.

- ① Detecting distance.
- ② Current consumption.
- ③ High level output voltage.
- ④ Low level output voltage.
- ⑤ Output Pulse width.
- ⑥ Visual inspection

7) Others

This product complies with the European Union's RoHS directive and halogen-free.  
It applies for the change in connection with the specification of a product in advance.  
In case any trouble or question arise, both parties agree to make full discussion covering the said problem.

 <p><b>RAYTRON CO., LTD.</b>  <b>HEAD OFFICE &amp; FACTORY (KOREA)</b>          104-6, Moonji-Dong, Yusung-Gu, Daejeon, KOREA          TEL : +82-42-863-2840 FAX : +82-42-861-0843  <b>FACTORY (CHINA)</b>          6/F, BlockA, Huafeng GongYeYuan, Bao'an72, Shenzhen, CHINA          TEL : +86-755-2744-7373 FAX : +86-755-2744-7235</p>	MANAGER	CHECK	APPROVAL
			
	FILE No.	RIS-120725-01	

CUSTOMER :

<b>SPECIFICATIONS</b>		SHEET No.	5 of 8
		DATE	2012. 07. 25
PART NAME	IR RECEIVER MODULE	MODEL NAME	
PART No.		TYPE No.	ROM-VB138THC2

**6. Reliability Test Item and Standard.**

- 1) All output products shall satisfy below Reliability test items.
- 2) Related sampling quantity and acceptance/failure judgment standard accordance with MIL standard MIL-STD-883 is as listed below.

① Confidence level : 90%

② LTPD : 10% / 20%

No.	Test Item	Test Conditions	Judgment Standard	Fail(c) / Samples(n)
1	High Temp. Storage (※2)	Ta=+90°C, t=500hr	1. V <sub>OH</sub> (V <sub>CC</sub> =5.0V) High level output voltage V <sub>OH</sub> > 4.5V  2. V <sub>OL</sub> (V <sub>CC</sub> =5.0V) Low level output voltage V <sub>OL</sub> < 0.4V  3. I <sub>CC</sub> (V <sub>CC</sub> =5.0V) Consumption current I <sub>CC</sub> < 1.0mA  4. D (V <sub>CC</sub> =5.0V) Arrival Distance D > 10m  Leads shall be covered By solder more than 95%	C=0 / n=22
2	Low Temp. Storage (※2)	Ta=-30°C, t=500hr		C=0 / n=22
3	High Temp. Operating (※1,※2)	Ta=+85°C, V <sub>CC</sub> =5.0V t=500hr		C=0 / n=22
4	Low Temp. Operating (※1,※2)	Ta=-20°C, V <sub>CC</sub> =5.0V t=500hr		C=0 / n=22
5	High Temp./ High Hum. Bias (※1,※2)	Ta=+85°C, 85%RH V <sub>CC</sub> =5.0V, t=500hr		C=0 / n=22
6	Temperature Cycle (※2, ※3)	Ta=-20°C(0.5h) to +85°C(0.5h) 20cycle		C=0 / n=22
7	P.C.T (※2)	Ta=+121°C 100%RH, P=1atm, t=4hr		C=0 / n=22
8	Solder Heat (※2)	Ta=+350±5°C, 3s		C=0 / n=11
9	Variable frequency Vibration (※2)	Frequency range : 10 to 55Hz/sweep 1min Overall amplitude : 1.5mm X,Y,Z/2h each		C=0 / n=11
10	Falling (※4)	Height=75cm, 3 times		C=0 / n=11
11	Solderability (※5)	Soldering Temp.: +260±5°C, 10s Pb free solder : Sn/3.0Ag/0.5Cu		C=0 / n=11

※1. Supply voltage of load test is 5V.(Standard Jig of Raytron)

※2. Electro-optical characteristics shall be satisfied after leaving 2 hours in the normal condition.

※3. Temperature cycle test shall repeat above condition 20 times under no load.

※4. The test devices shall be dropped three time on the hard wooden board from a height of 75cm.

※5. Reflow Soldering.

☞ In case any trouble or question arises related to above test items, both parties agree to make full discussion and covering the said matters.

 <p><b>RAYTRON CO., LTD.</b>                  HEAD OFFICE &amp; FACTORY (KOREA)                  104-6, Moonji-Dong, Yusung-Gu, Daejeon, KOREA                  TEL : +82-42-863-2840 FAX : +82-42-861-0843                  FACTORY (CHINA)                  6/F, BlockA, Huafeng GongYeYuan, Bao'an72, Shenzhen, CHINA                  TEL : +86-755-2744-7373 FAX : +86-755-2744-7235</p>	MANAGER	CHECK	APPROVAL
			
	FILE No.	RIS-120725-01	

CUSTOMER :

<b>SPECIFICATIONS</b>		SHEET No.	6 of 8
		DATE	2012. 07. 25
PART NAME	IR RECEIVER MODULE	MODEL NAME	
PART No.		TYPE No.	ROM-VB138THC2

3) Electrostatic Discharge test result.

ESD Testing was performed on Zapmaster system using the Human-Body-Model(H.B.M) and Machine-Model(M.M) according to JESD22-A114D and JESD22-A115-A respectively.

- ① Human Body Model stress devices by a sudden high voltage supplied to application by a 100pF Capacitor through 1.5kΩ resistance.
- ② Machine Model stress devices by a sudden high voltage supplied to application by a 200pF capacitor very low 0Ω resistance.
- ③ Test Circuit.

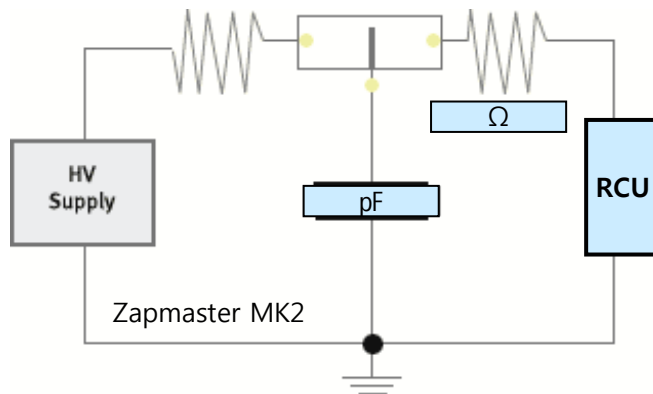

④ Results of E.S.D Test.

Model	Mode	Level Criteria	Test Result
HBM	GND	2,000 V	7,000 V Pass
	VDD	2,000 V	7,000 V Pass
	I/O	2,000 V	7,000 V Pass
MM	GND	200 V	700 V Pass
	VDD	200 V	700 V Pass
	I/O	200 V	700 V Pass



**RAYTRON CO., LTD.**

**HEAD OFFICE & FACTORY (KOREA)**  
 104-6, Moonji-Dong, Yusung-Gu, Daejeon, KOREA  
 TEL : +82-42-863-2840 FAX : +82-42-861-0843

**FACTORY (CHINA)**  
 6/F, BlockA, Huafeng GongYeYuan, Bao'an72, Shenzhen, CHINA  
 TEL : +86-755-2744-7373 FAX : +86-755-2744-7235

MANAGER	CHECK	APPROVAL
FILE No.	RIS-120725-01	



CUSTOMER :

<h1>SPECIFICATIONS</h1>		SHEET No.	7 of 8
		DATE	2012. 07. 25
PART NAME	IR RECEIVER MODULE	MODEL NAME	
PART No.		TYPE No.	ROM-VB138THC2

## 7. Packing Specifications

### 1) Label Specification (Bar Code Sticker)

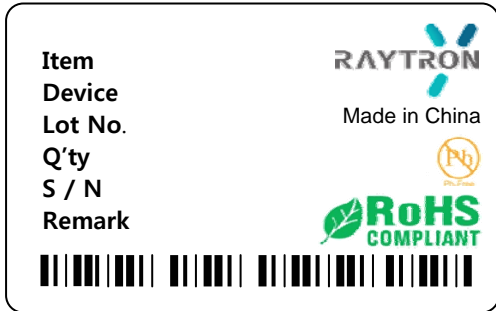

Label Dimensions (Unit : mm)

Label Type	L	W	Remark
Label #1	65	40	

### 2) Box Specifications & Packing Method

(Unit : mm)

Packing Type	Materials	L x W x H	Quantity
Shielding Bag	Polyethylene	120 x 160 x 0.15	150 pcs
RM-#1	Corrugated Cardboard	140 x 217 x 73	750 pcs
RM-#2	Corrugated Cardboard	395 x 300 x 245	7,500 pcs
RM-#4	Corrugated Cardboard	620 x 410 x 520	30,000 pcs



1. Put 150pcs of products in a Shielding Bag.

2. Put 5pcs of Shielding Bag.



4. Put 4pcs of #2 packing boxes in a #4 packing box.

3. Put them(10pcs of #1) in a #2 packing box.



## RAYTRON CO., LTD.

**HEAD OFFICE & FACTORY (KOREA)**  
 104-6, Moonji-Dong, Yusung-Gu, Daejeon, KOREA  
 TEL : +82-42-863-2840 FAX : +82-42-861-0843

**FACTORY (CHINA)**  
 6/F, BlockA, Huafeng GongYeYuan, Bao'an72, Shenzhen, CHINA  
 TEL : +86-755-2744-7373 FAX : +86-755-2744-7235

MANAGER CHECK APPROVAL

FILE No.

RIS-120725-01

CUSTOMER :

<h1>SPECIFICATIONS</h1>		SHEET No.	8 of 8
		DATE	2012. 07. 25
PART NAME	IR RECEIVER MODULE	MODEL NAME	
PART No.		TYPE No.	ROM-VB138THC2

**8. Appearance & Dimensions (mm)**

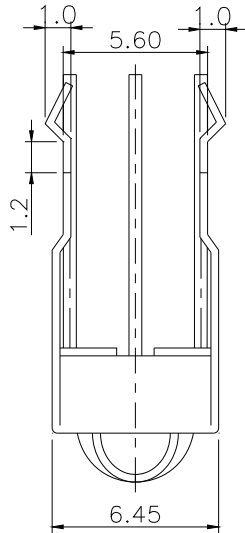

Example of Mounting drawing from Solder Side (Reference)

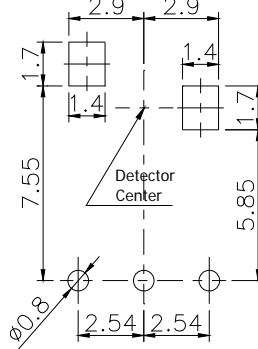

- 1. Pin Config.
- ① Vout
- ② Vcc
- ③ GND
- 2. G.T : ±0.3

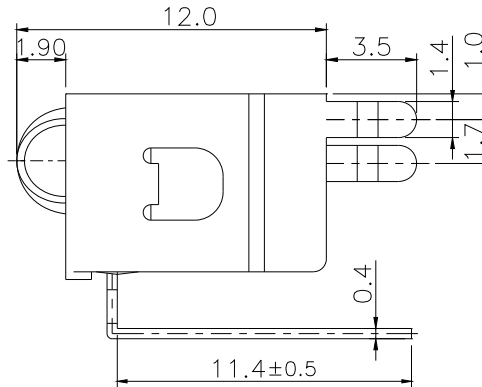
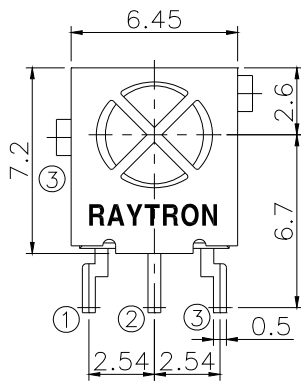

Component	Materials	Remark
Pin Photo Diode	Silicone	
Pre-amp IC	Silicone	
Lead Frame	Fe (Ag plating)	Lead part solder dipping
Die Attach	Ag Paste	
Wire	Au Wire	
Molding	Non-fireproof epoxy resin	Transfer Mold
Shield Case	Fe (Sn plating)	



**RAYTRON CO., LTD.**

HEAD OFFICE & FACTORY (KOREA)  
 104-6, Moonji-Dong, Yusung-Gu, Daejeon, KOREA  
 TEL : +82-42-863-2840 FAX : +82-42-861-0843

FACTORY (CHINA)  
 6/F, BlockA, Huafeng GongYeYuan, Bao'an72, Shenzhen, CHINA  
 TEL : +86-755-2744-7373 FAX : +86-755-2744-7235

MANAGER	CHECK	APPROVAL
FILE No.	RIS-120725-01	